

CoolLED

LED DRIVERS

CLH200
Single Channel



Up to 200W

500mA, 700mA, 1000mA, 1400mA & 1650mA

Dimming / Control Options

DALI, 0-10V, 1-10V (Analogue) / Switched Dim (PIR/ relay), LeafNut and SmartNight

NTC temperature control / Thermal protection

Reduces output power progressively to a min of 10% I Max before ultimately switching off if the temperature continues to rise.

Resistive Programming

Single Channel Unit - 200W

Output voltage non SELV (>120V)

Reinforced insulation between primary, secondary and control when using 0-10V, 1-10V, DALI



Product Description

- 120 - 277V nominal input voltage
- High power
- Smart Night available on request
- Dimming to 5%
- Up to 93% efficiency
- Screw or push in terminals
- Power factor >0.95 at full load

Wiring diagram

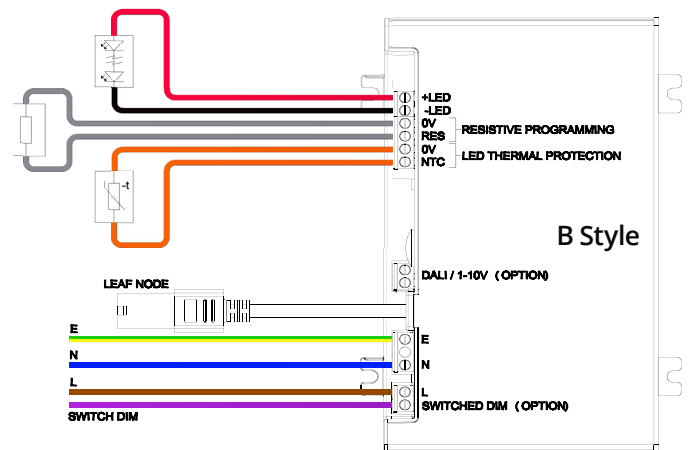

LeafNut, our multi award winning street lighting control system is revolutionising outdoor lighting with over 400,000 street lights being deployed worldwide.



Compatibility with LeafNut CMS as standard.

LeafNut has been developed by our UK based research and development team and uses ground-breaking wireless technology to cut carbon emissions and reduce energy consumption.

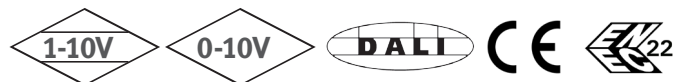

Technical Specification

Mains input voltage	120 - 277V nominal (108V - 305V absolute limits)
Mains frequency	50 - 60Hz
Output power range	200W max (150W max for CLH150)
Power factor	>0.95 at full load
Efficiency at full load	92%
Mains surge protection	4kV Common mode, 2kV differential mode
Input - Output isolation	3kV reinforced insulation
Humidity	90% max non-condensing
Thermal reduction	Power reduces when case temperature reaches TC max
Ambient temperature range	-25°C to 50°C
Maximum Tc temperature	80°C
Dimming range	100% - 5% I max
Enclosure	Extruded Aluminum
Wire size	0.64mm to 1mm / 22AWG - 18AWG
Lifetime	TC 70°C>100,000 hours (see handbook)
Weight	1.166kg

Case Style	Dimensions	Weight	Box Quantity
B - Integral	169mm x 100mm x 42.48mm	1.166kg	12



Tolerance: + or - 0.5mm

Compliance

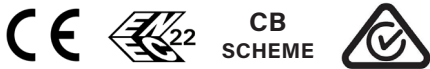
Approval	Standards
ENEC (Europe)	EN61347-1:2008+A1:2011+A2:2013, EN61347-2-13:2014, EN62384:2006+A1:2009
CE (Europe)	LVD:2014/35/EU; EMC:2014/30/EU; RoHS:2011/65/EU; ECOD/2009/125/EC
CB (International)	IEC 61347-1:2007 (second edition)+A1:2010 +A2:2012; IEC 61347-2-13:2014 (second edition); IEC 62384:2006 (First edition)+A1:2009



Variants

	Part number	Current (at maximum LED current)	LED String Voltage	Ripple (typical Pk-Pk @ full load)	
				100/120Hz	60kHz
	CLH200-500-UNI-B-WM	500mA ($\pm 5\%$)	75V-400V	60mA	95mA
	CLH200-700-UNI-B-WM	700mA ($\pm 5\%$)	53.4V-285V	90mA	135mA
	CLH200-700-UNI-B-CC-WM	700mA ($\pm 5\%$)	53.4V-285V	90mA	135mA
	CLH200-1000-UNI-B-WM	1000mA ($\pm 5\%$)	37.5V-200V	115mA	270mA
	CLH200-500A-UNI-B	500mA ($\pm 5\%$)	75V-400V	60mA	95mA
	CLH200-700A-UNI-B	700mA ($\pm 5\%$)	55V-286V	90mA	135mA
	CLH200-1000A-UNI-B	1000mA ($\pm 5\%$)	40V-200V	115mA	270mA
	CLH200-1400A-UNI-B	1400mA ($\pm 5\%$)	26.6V-142V	130mA	290mA
	CLH200-500D-UNI-B	500mA ($\pm 5\%$)	75V-400V	60mA	95mA
	CLH200-700D-UNI-B	700mA ($\pm 5\%$)	53.4V-285V	90mA	135mA
	CLH200-1000D-UNI-B	1000mA ($\pm 5\%$)	37.5V-200V	115mA	270mA
	CLH200-1400D-UNI-B	1400mA ($\pm 5\%$)	26.6V-142V	130mA	290mA
	CLH200-1650D-UNI-B	1650mA ($\pm 5\%$)	25V-121V	172mA	220mA

Please note: Conformal coated versions are available on request

Dimensions

B Style (Integral)

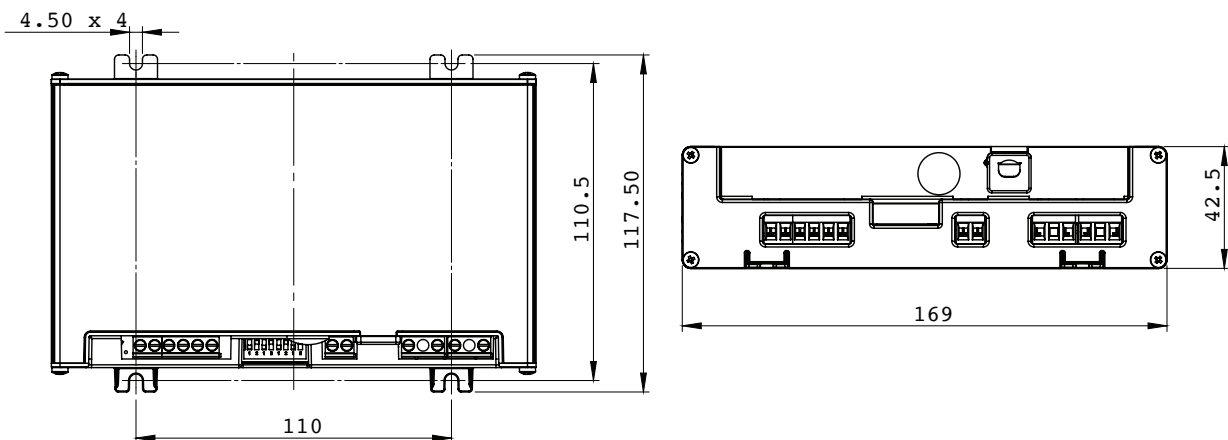

Harvard Power Systems Limited

Tyler Close, Normanton, Wakefield, WF6 1RL, UK

Tel: +44 (0)113 880 5405



www.Harvardps.com

Voltage Vs Current

Harvard High Power CLH200-UNI LED Driver Range

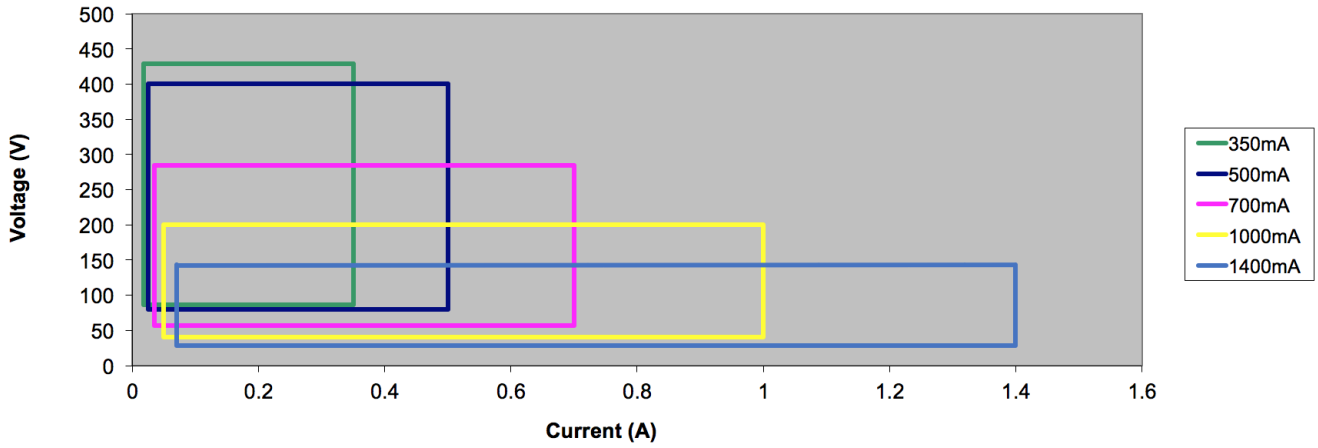

Power Factor Vs Output Power at 240V

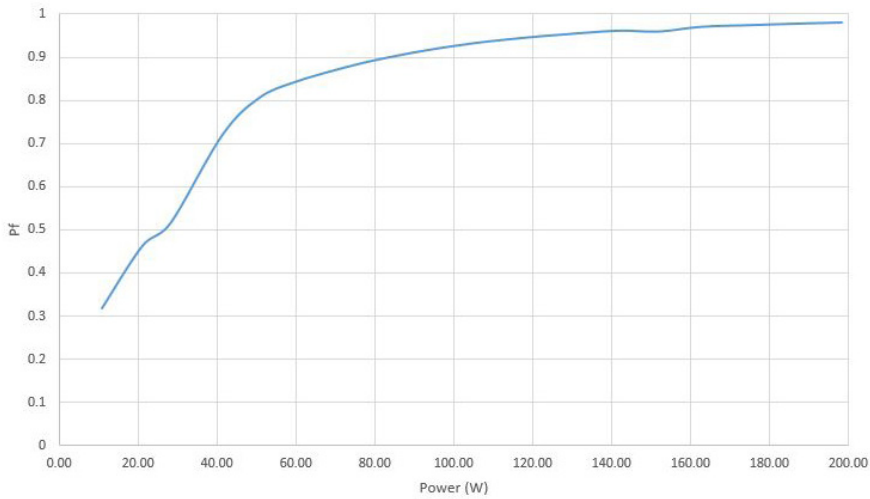
**Harvard Power Systems Limited**

Tyler Close, Normanton, Wakefield, WF6 1RL, UK

Tel: +44 (0)113 880 5405

www.Harvardps.com

Efficiency Vs Output Voltage

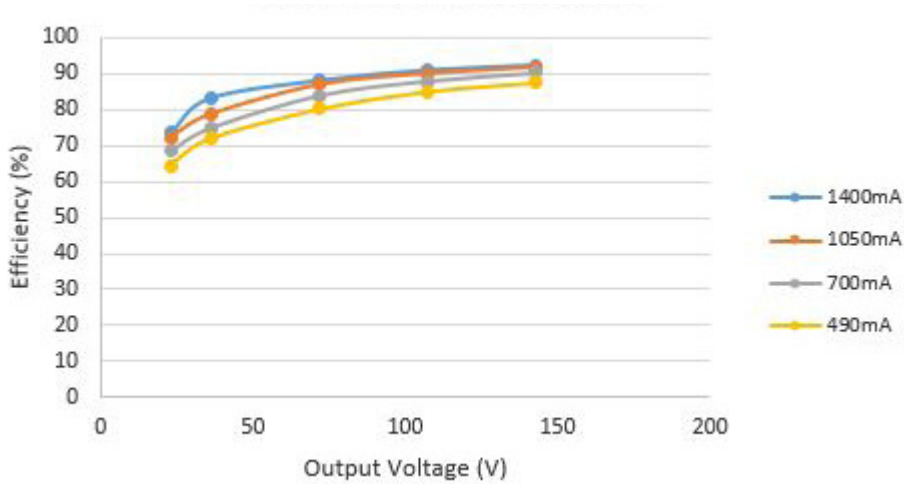

THD Vs Load

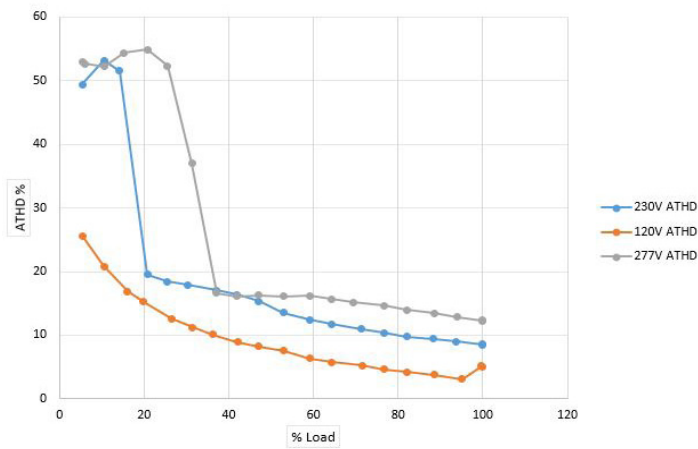

PLEASE NOTE

Information given in this datasheet is for illustration purposes only and subject to change without prior notice. No liability is accepted for printing errors. Reference made to third party approval or certification may be subject to ongoing licence transfers and may not be fully implemented.



Harvard Power Systems Limited

Tyler Close, Normanton, Wakefield, WF6 1RL, UK

Tel: +44 (0)113 880 5405



www.Harvardps.com